

Part Design Guidelines for Injection Molded Thermoplastics

Recommended by our Computer-Aided Engineering Support Services

Designing Your Plastic Part

When designing parts for injection molding, the manufacturing process is an important consideration. Injection molding is a process in which solid thermoplastic resin pellets are melted, injected into a mold, and then cooled back to a solid state in a new form. During both the injection and cooling stages of the manufacturing process, there are several factors that may affect the quality of the final product and the repeatability of the manufacturing process. Although it is not always possible to follow all recommendations, outlined on the following pages are some of the most fundamental guidelines when designing parts for injection molding.

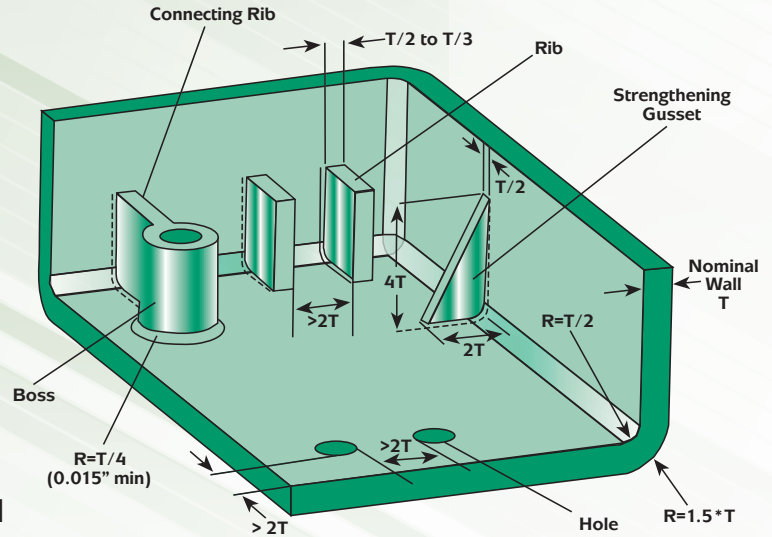

Typical Metal Design:

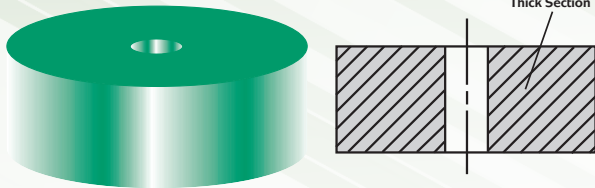

Preferred Plastic Design:

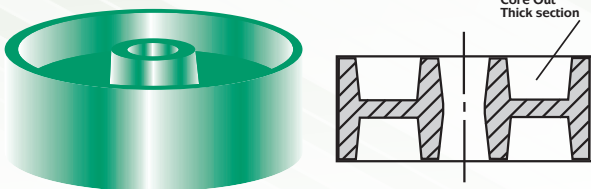

Metal parts are often designed with thick walls, while plastic parts should ideally maintain uniform wall thickness for uniform flow and less shrinkage.

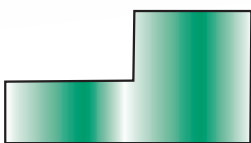

Not Recommended

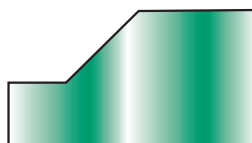

Recommended

Design Recommendations:

Wall Thickness

- Maintain a wall thickness of less than 5mm because thick walls can lead to long cycle times and poor mechanical properties.
- Avoid large variations in wall thicknesses in order to simplify flow pattern and minimize variations in shrinkage that can lead to warpage.
- Avoid abrupt changes in wall thickness, as this can create stress concentration areas that may reduce a part's impact strength. Wall thickness changes should have transition zones that reduce the possibility of stress concentrations, sinks, voids, and warp.
- Avoid gating near an area with a large variation in wall thickness because hesitation and race tracking can create non-uniform flow and shrinkage.

For plastic parts, a gradual change in wall thickness is recommended to reduce stress concentration and other potential issues.

Radii

- An inside radius should be at least 50 percent of the nominal wall thickness.
- An outside radius should be the nominal wall thickness plus the inside radius (150 percent of nominal wall).
- Sharp corners at the base of bosses and ribs can be stress concentrators. The edge where a boss meets the nominal wall should be radiused to reduce the sharp corner without increasing the wall thickness enough that it creates a sink problem.
- The radius at the base of a boss should be $\frac{1}{4}$ of the nominal wall with a minimum radius of 0.015”.

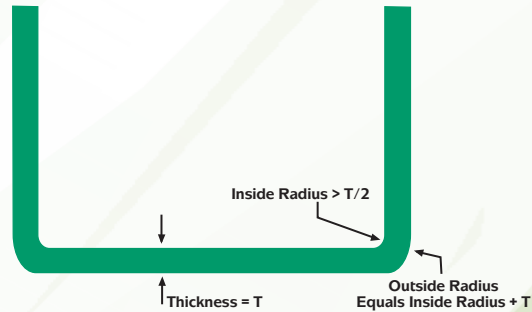

The desired radii of adjoining walls are related to wall thickness.

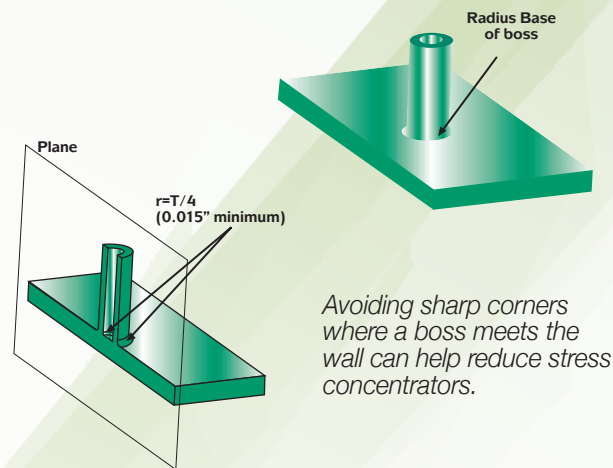

Avoiding sharp corners where a boss meets the wall can help reduce stress concentrators.

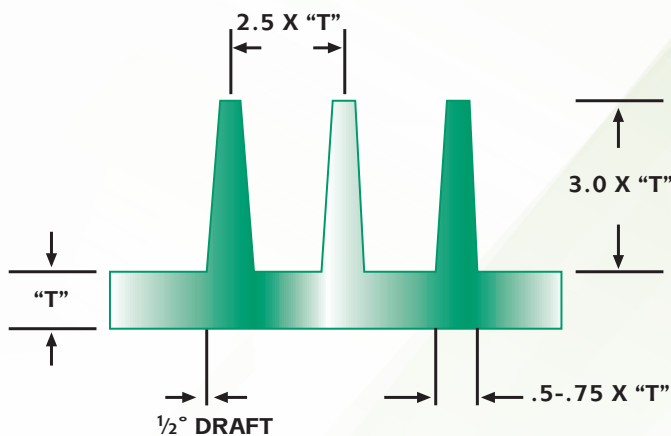

In addition to rib thickness and height, the draft angle should also be taken into consideration. See the “Draft Angle” section for more information.

Ribs

- Maximum rib thickness should be 0.5 to 0.75 of the nominal wall to avoid creating areas of sink.
- To avoid thin sections of steel in your mold, the distance between ribs should be at least two and a half times the nominal wall thickness.
- Ribs should have a draft angle of at least $\frac{1}{2}^\circ$ per side in order to accommodate easier ejection from the mold.
- Maximum rib height should be no greater than three times the nominal wall thickness in order to avoid large variations in wall thickness.
- Balance ribs on both sides of the nominal wall to avoid non-uniform shrink that can lead to warpage.

Careful design of boss dimensions and part ratios is helpful in optimizing structure.

Bosses

- Stand-alone bosses should be designed following the design guidelines for ribs (see more information under the "Ribs" section).
- Use connecting ribs and/or supporting gussets if possible to stiffen structural parts. Connecting ribs should be 0.6 times the nominal wall thickness at their base to avoid sink.
- To maintain uniform wall thickness, bosses should be cored to the bottom of the boss.

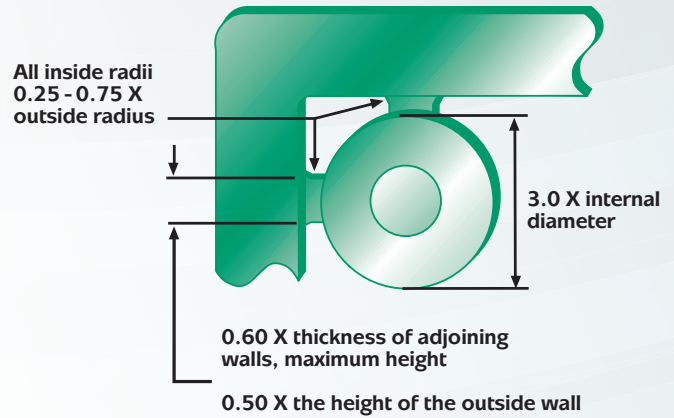

Plastic threads are designed differently than metal threads with larger crests and depth of roots.

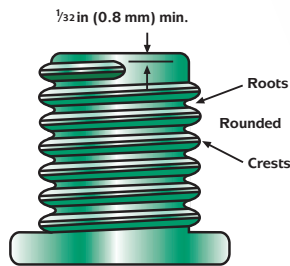
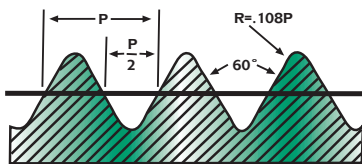

Threads

Plastic threads used for joining parts can be machined or molded-in.

- When designing molded-in threads, avoid feathered edges and include radiused roots in order to minimize stress concentrations and to keep the walls uniform.
- Sharp edges can be stress concentrators in plastic parts. Thread designs should consider this.

Draft Angle

- Design parts with a minimum of $\frac{1}{2}^\circ$ per side draft in order to accommodate easier ejection from the mold.

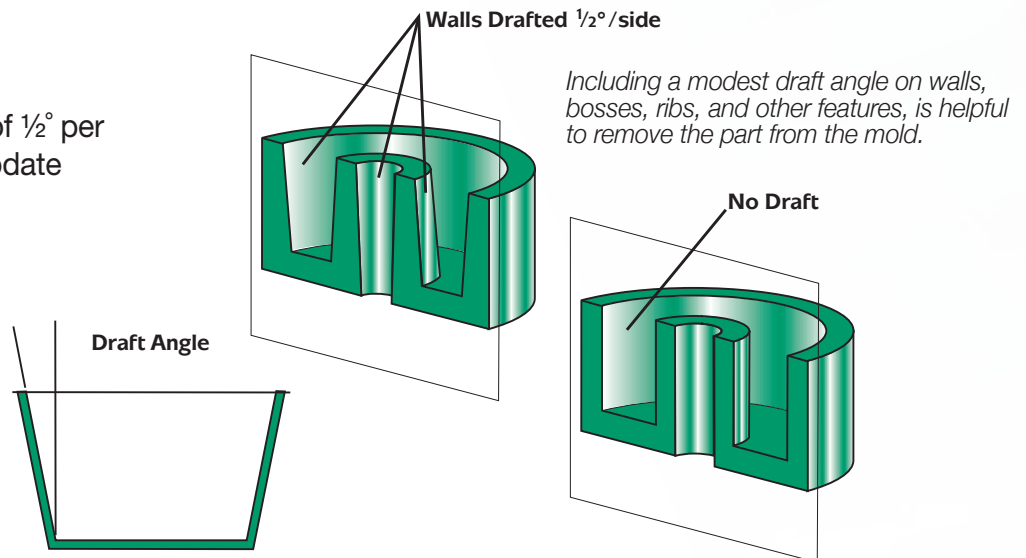

Amorphous Versus Semi-Crystalline Materials:

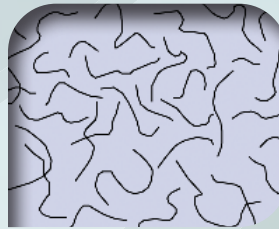

Amorphous Materials

In amorphous materials, molecules are randomly oriented and intertwined. Polymer molecules have no ordered structure. These materials have no identifiable “melting point” but progressively soften through a broad temperature range. Unfilled amorphous materials are typically isotropic, shrinking equally in the flow and transverse directions. Even fiber-filled amorphous materials typically have low shrink and good dimensional control.

Typical Shrinkage Values for Amorphous Materials
Based on a 1/8" (3.2mm) section using ASTM D 955

Material	Mold Shrinkage (in./in.)
Unfilled Acrylonitrile Butadiene Styrene (ABS)	0.004 – 0.008
Unfilled Polycarbonate (PC)	0.003 – 0.007
Unfilled Polysulfone (PSU)	0.003 – 0.007
Unfilled Polyetherimide (PEI)	0.004 – 0.009
Unfilled Acrylic (PMMA)	0.003 – 0.007

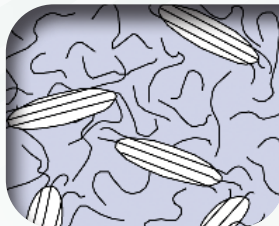

Semi-Crystalline materials

Semi-crystalline materials have areas of random molecule orientation but they also contain regions where molecules pack together to form ordered crystalline structures. These materials have a sharp melting point and are typically solvent resistant. These materials can be anisotropic which means they shrink differently in the flow versus transverse directions.

Typical Shrinkage Values for Semi-Crystalline Materials
Based on a 1/8" (3.2mm) section using ASTM D 955

Material	Mold Shrinkage (in./in.)
Unfilled Polypropylene (PP)	0.010 - 0.025
Talc filled Polypropylene (PP)	0.007 - 0.015
High Density Polyethylene (HDPE)	0.015 - 0.040
Unfilled Nylon 6	0.005 – 0.015
Unfilled Nylon 6/6	0.008 – 0.015
Acetal (POM)	0.020 – 0.025

Key Definitions

Amorphous Polymer	A polymer characterized by random entangled polymer chains. Generally amorphous materials have lower shrink and better dimensional stability than semi-crystalline materials.
Anisotropic	Not the same in all directions. This term might be applied to shrinkage for materials that shrink differently in the direction of flow than they do across the flow direction. Filled materials usually exhibit anisotropic shrinkage.
Cavity/Core	The cavity is the depression in the mold that forms the outer surface of the molded part. A core is a male part of a mold that shapes the inside of a molded part.
Ejector Pin/Knockout Pin	A pin that ejects a molded piece from the mold. Ejector pins typically leave a small indentation on the plastic surface.
Flash	Excess plastic around the area of a molded parting line that appears as a standing edge on the molded part.
Gate	The channel through which molten polymer flows into the molded part. It is typically small and leaves a mark on the molded part.
Isotropic	The same in all directions. This term might be applied to shrinkage or other mechanical properties of a material. Unfilled materials are more likely to be isotropic.
Parting Line	The line formed by the mating surfaces of the mold halves.
Runner	The feed channel that plastic flows through to get from the injection unit sprue to the gate of the molded part.
Semi-crystalline Polymer	A polymer characterized by areas of order in which molecular chains line up. Semi-crystalline materials tend to have good chemical resistance but higher shrink than amorphous materials.
Sink	A depression in a molded plastic part caused by a thicker section of plastic shrinking and collapsing as it cools.
Undercut	A protrusion or indentation that impedes the withdrawal of a molded part from a two-piece, rigid mold.
Viscosity	The measure of the resistance of a fluid to movement. Lower viscosity means easier flowing, and high viscosity materials are more difficult to push.
Weld/Meld Line	Sometimes-visible marks on the surface of a molded part where two separate flow fronts of plastic have come together. Weld lines often have reduced mechanical properties, and weld lines should be located away from structurally important areas of the molded part.
Void	A pocket of unfilled space or vacuum in a molded part usually caused by the shrinkage during cooling of thick sections.



(case study) Speaker Mount for Casino Gaming System

When WMS Gaming, Inc., and their molder, Top Die Plastics, Inc., collaborated to develop a premium sound system for a casino gaming device, they wanted to use a single material that could provide strength, electrostatic dissipation, and flame retardant properties. Engineers from RTP Company recommended an RTP 300 Series static dissipative compound; however, the requirement of both Conductive and Flame Retardant additives was a concern, as the combination of the two raises the melt viscosity.

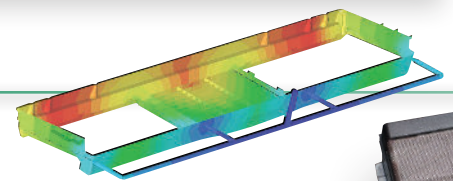

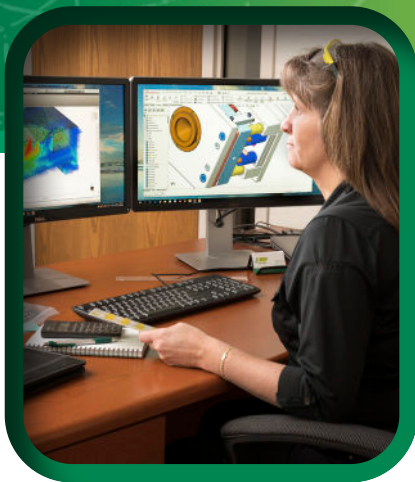

Support Services from RTP Company

RTP Company has a team of experienced Computer-Aided Engineering (CAE) analysts who can assist in providing material data, structural analysis, as well as filling and warpage analyses utilizing Moldflow®. We offer product design review and consultation of the following:

- Innovative thermoplastic solutions that optimize your design and cut processing costs
- Injection molding analysis
- Structural analysis (FEA)
- Plastic part design assistance
- Mold design assistance
- Structural failure consultation
- Composite materials design assistance and education
- Quick mechanical structural design review
- Product testing recommendation

Material Data Assistance:

RTP Company can provide guidance and material data for customers doing their own CAE analysis. We offer in-house testing and curve-fitting for both standard and custom materials. Your custom materials data will be processed with RTP Company's strict confidentiality procedures. We have over 400 materials characterized for flow simulation and if your material is not already characterized, we can test it for you.

Data sheet properties are generated on carefully designed molded specimens, and these properties do not always reflect the performance of an actual part, often due to fiber orientation. RTP Company can assist by providing data on how materials perform in different directions, as shown on this stress/strain curve.

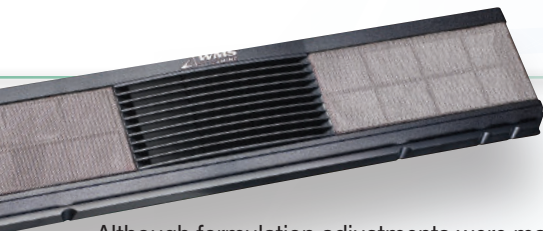
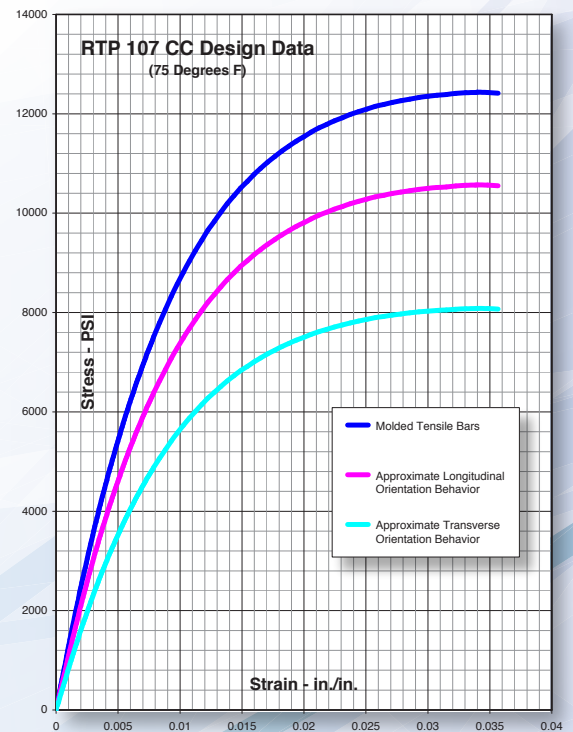

Although formulation adjustments were made to create a higher flow grade, WMS Gaming feared that they would still need to create an expensive and time-consuming three-plate mold for consistent part filling. Instead, RTP Company's Computer-Aided Engineering team performed a mold-flow analysis to model the material's characteristics with the existing mold plan. Successive iterations of the molding analysis tested alternate runner sizes and gate locations to optimize the mold design. "Performing such an analysis before cutting steel not only spared expense, but also kept the project on schedule," stated Norm Wurz, of WMS Gaming. "RTP Company increased the value of our product by providing support to customize it specifically to meet our needs."



**STRUCTURAL • ELASTOMERS • WEAR • COLOR
CONDUCTIVE • FLAME RETARDANT • FILM/SHEET**

Your Global Compounder of Custom Engineered Thermoplastics

RTP COMPANY is committed to providing you with solutions, customization, and service for all of your thermoplastic needs. Our dedicated staff cares for your company and delivers personalized service and expertise to help you meet even your most challenging application requirements.

COMPUTER-AIDED ENGINEERING SUPPORT (CAE)

RTP Company has a dedicated CAE Services team ready to assist you with technical design issues, from conception of an ideal to final part manufacturing.

HIGH VOLUME CAPABILITIES

Our Alloy Polymers™ facilities provide high volume and tolling services, featuring confidential, efficient operations and timely, large-scale delivery.

CUSTOM ENGINEERING

RTP Company works in every thermoplastic resin system with hundreds of modifiers to develop the right solution for your application.

TOLL COMPOUNDING

RTP Company's toll and contract manufacturing division gives resin producers and distributors the ability to offer specialty compounds branded with their own label.

No information supplied by RTP Company constitutes a warranty regarding product performance or use. Any information regarding performance or use is only offered as suggestion for investigation for use, based upon RTP Company or other customer experience.

RTP Company makes no warranties, expressed or implied, concerning the suitability or fitness of any of its products for any particular purpose. It is the responsibility of the customer to determine that the product is safe, lawful and technically suitable for the intended use. The disclosure of information herein is not a license to operate under, or a recommendation to infringe any patents.

Copyright 2017 RTP Company, 3/17

Please contact your local RTP Company Sales Engineer by calling **1-507-454-6900**
1-800-433-4787 (U.S. only), E-mail rtp@rtpcompany.com or visit www.rtpcompany.com



RTP Company Corporate Headquarters • 580 East Front Street • Winona, Minnesota 55987 USA website: www.rtpcompany.com • email: rtp@rtpcompany.com

TELEPHONE:	U.S.A. +1 507-454-6900	SOUTH AMERICA +55 11 4193-8772	MEXICO +52 81 8134-0403	EUROPE +33 380-253-000	SINGAPORE +65 6863-6580	CHINA +86 512-6283-8383	Wiman Corporation +1 320-259-2554	ESP™ +1 800-432-2386
------------	---------------------------	-----------------------------------	----------------------------	---------------------------	----------------------------	----------------------------	--------------------------------------	-------------------------

